

**Towel Bar**  
6860-10-81CP

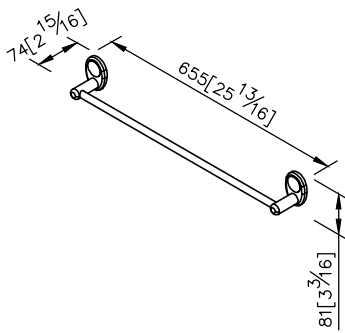

- 1.Brass of forging body meets JIS 3771 standard.
- 2.Premium metal construction for durability.
- 3.Justime finishes resist corrosion and tarnish.
- 4.Finish meets the standard of ASTM-SC2.
- 5.The simply design concept could be collocated with diverse space.
- 6.Correctly installed product's loading is 4 kgf.
- 7.The size of towel bar: 600mm.
- 8.Coordinates with other products in 6860 collection.

unit: mm[inch]

