

Tumbler Holder

6899-30-80S1

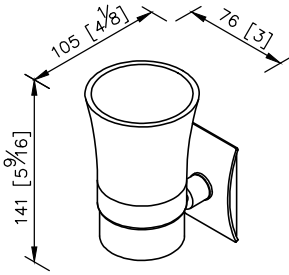

unit: mm[inch]

1. Stainless steel faceplate and tumbler ring.
2. Plastic mounting base with brass core.
3. Stainless Steel faceplate and ring meet SUS 304 standard.
4. Justime finishes resist corrosion and tarnish.
5. Finish meets the standard of ASTM-SC2.
6. Porcelain white tumbler.
7. After well installed ring can load up to 2 Kgf.
8. Capacity of the tumbler is 180ml.
9. Coordinates with other products in 6899 collection.

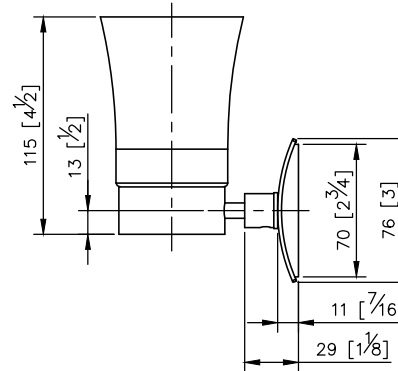
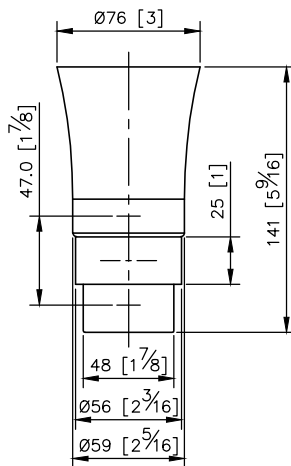
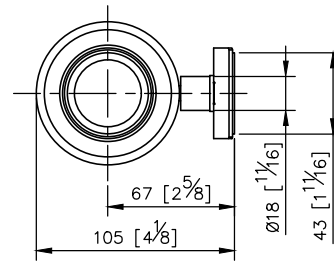

Mounting Template Specification

